

PCB #1

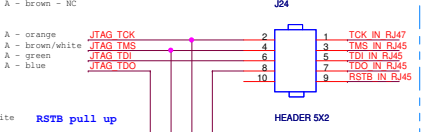

PCB #2

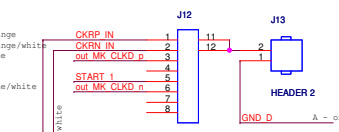
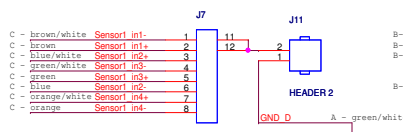
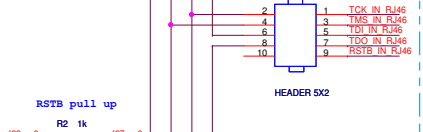
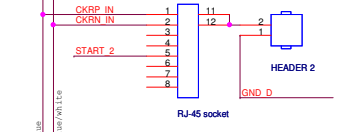
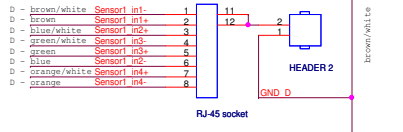

PCB #3

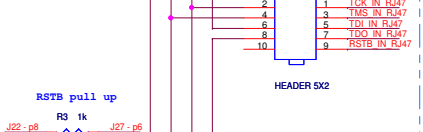
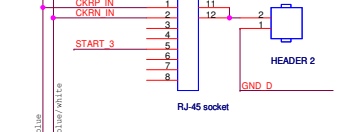
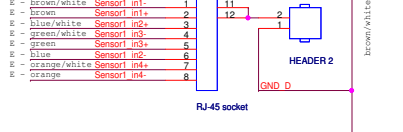

PCB #4

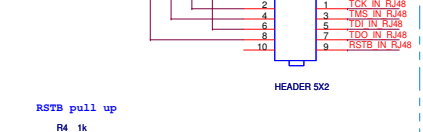
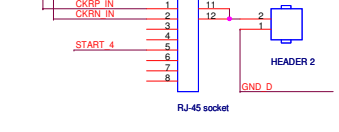
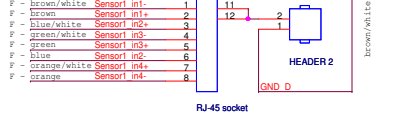

B - green
B - green/white

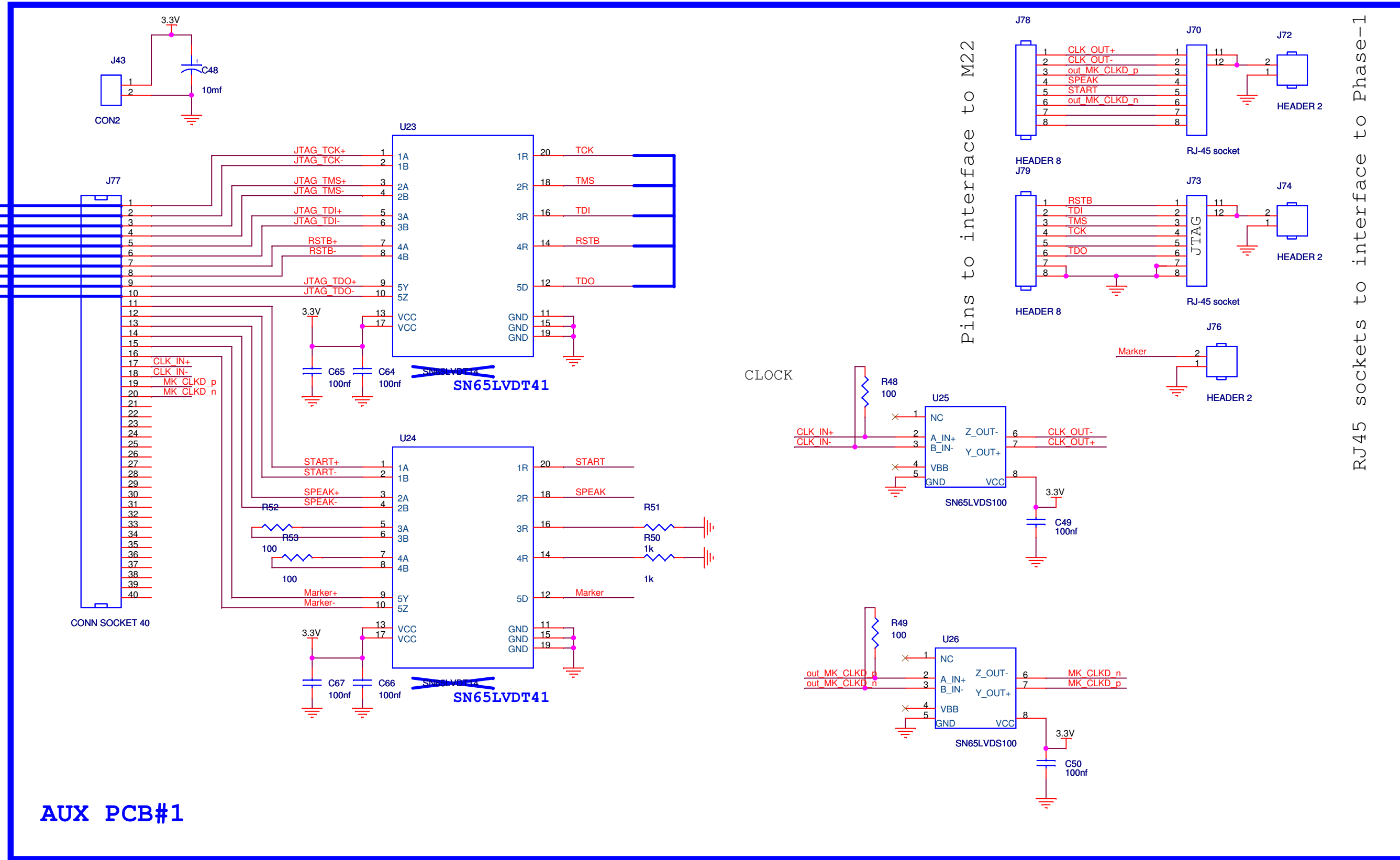

Pins to interface to M22

RJ45 sockets to interface to Phase-1

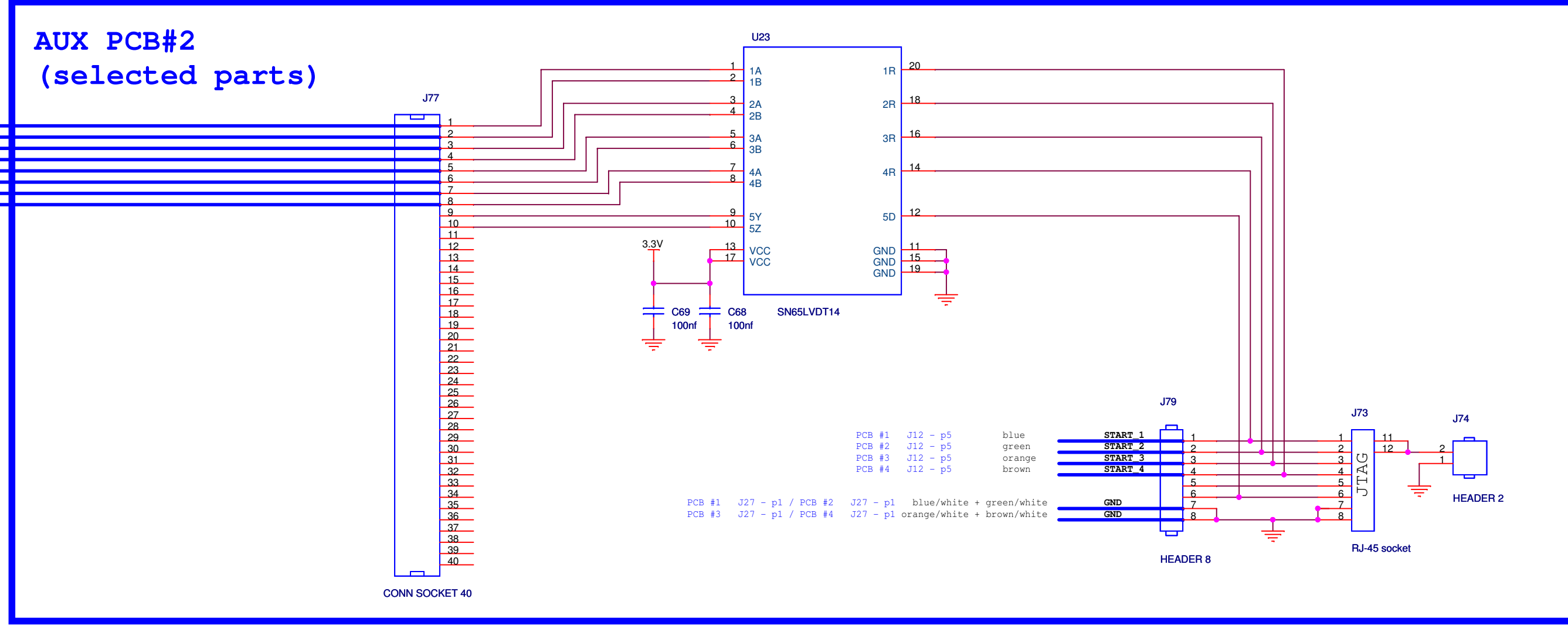

Title	Phase-2 telescope wiring (page 2/2)	
Size	Document Number	Rev
C	<Doc>	<Rev Code>
Date:	Tuesday, November 02, 2010	Sheet 1 of 1